

260329
441000
450080
452212
453212
454212
45072010
45077011
45272010
45277011
45472010
45477011
MASW34935
MASW39775
MASW53817
MASW54091
MASW63820
ST4203

450080

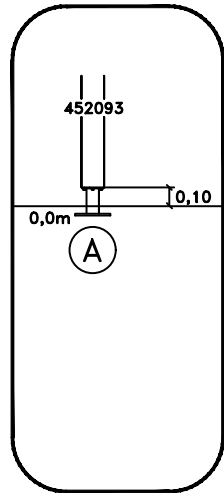

OM
Above Ground
 8081546

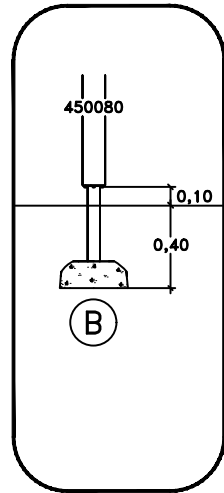

SF
Sunken Foundation
 8061776
 8089592

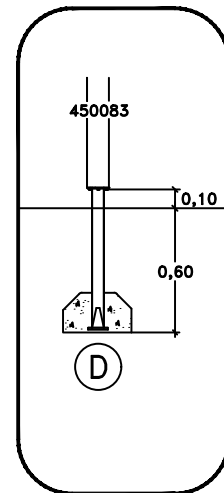

CC
Cast In Place
 8063283
 8066924

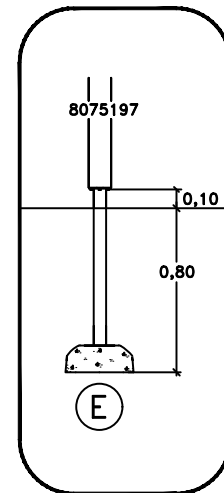

BM
Loosefill
 8070744

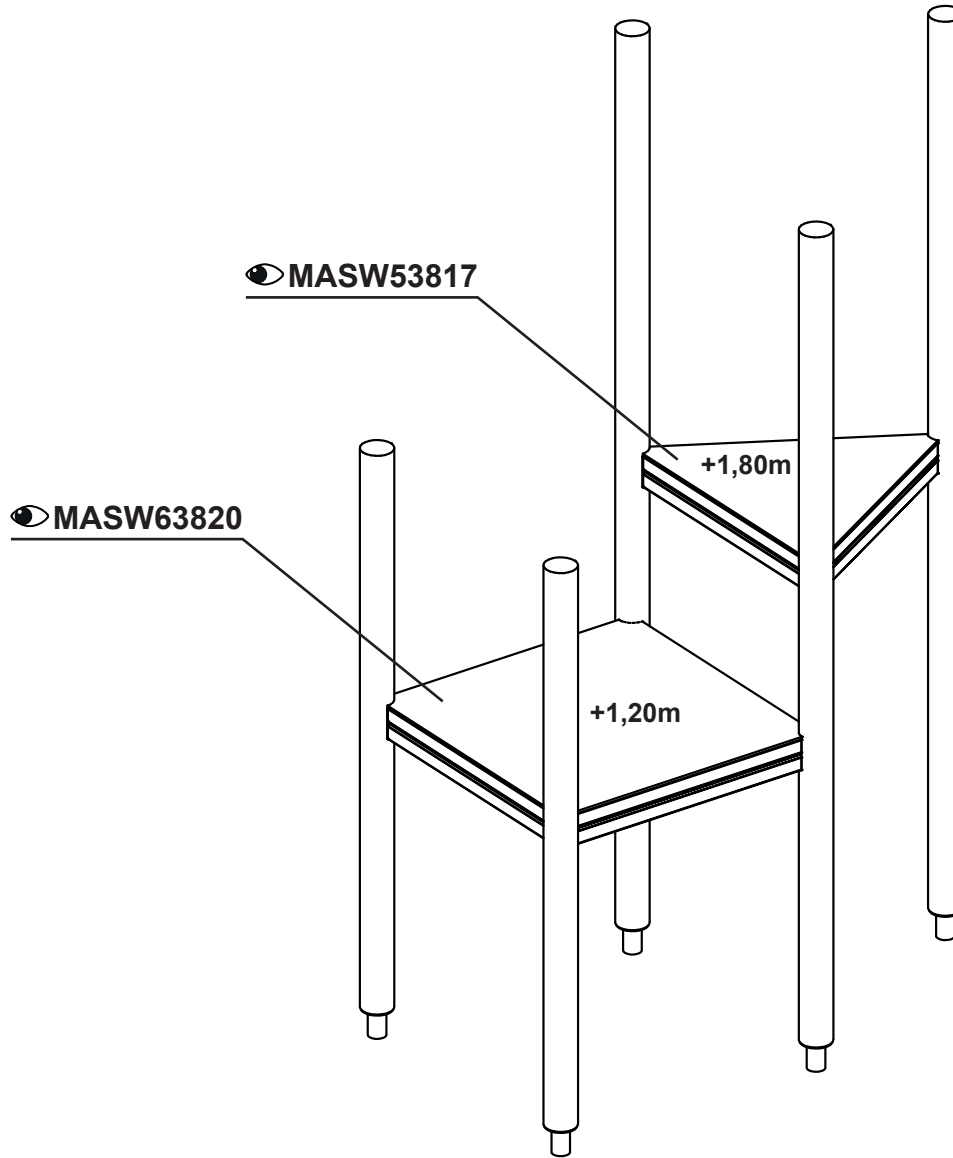
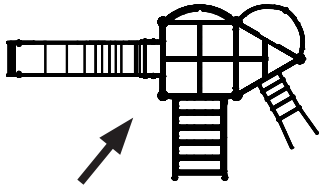

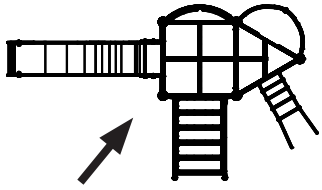

ST4203
8060671

MASW34935

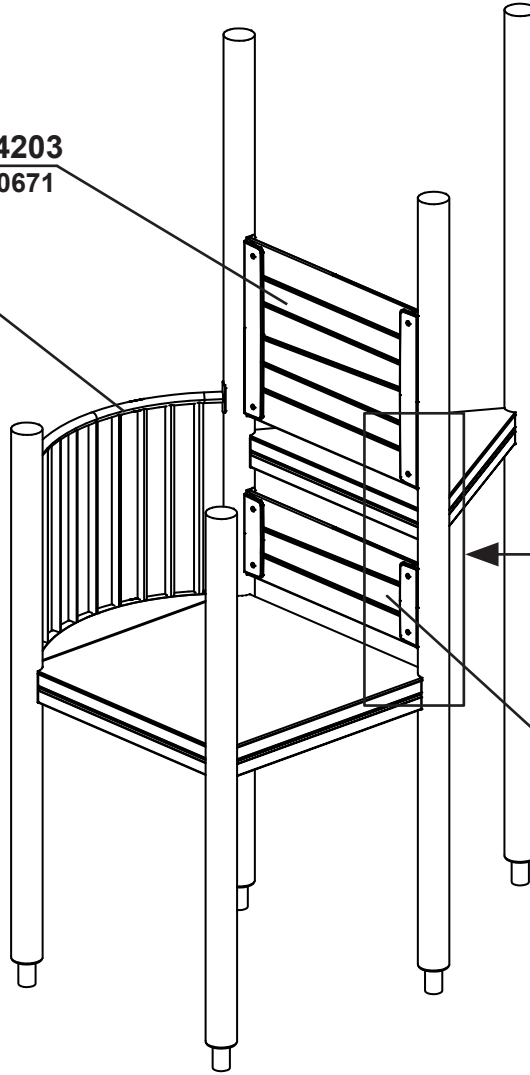

ST4203
8060669

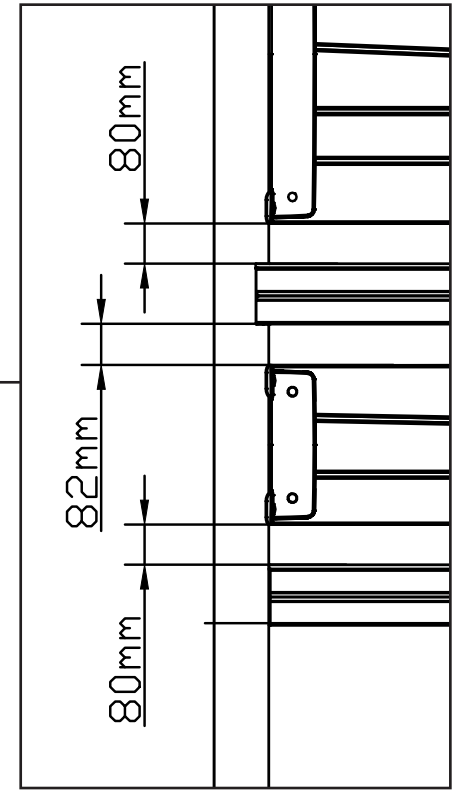

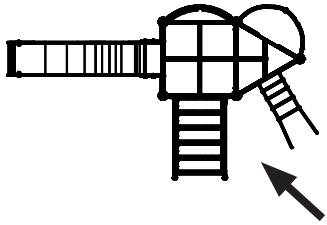

● MASW54091

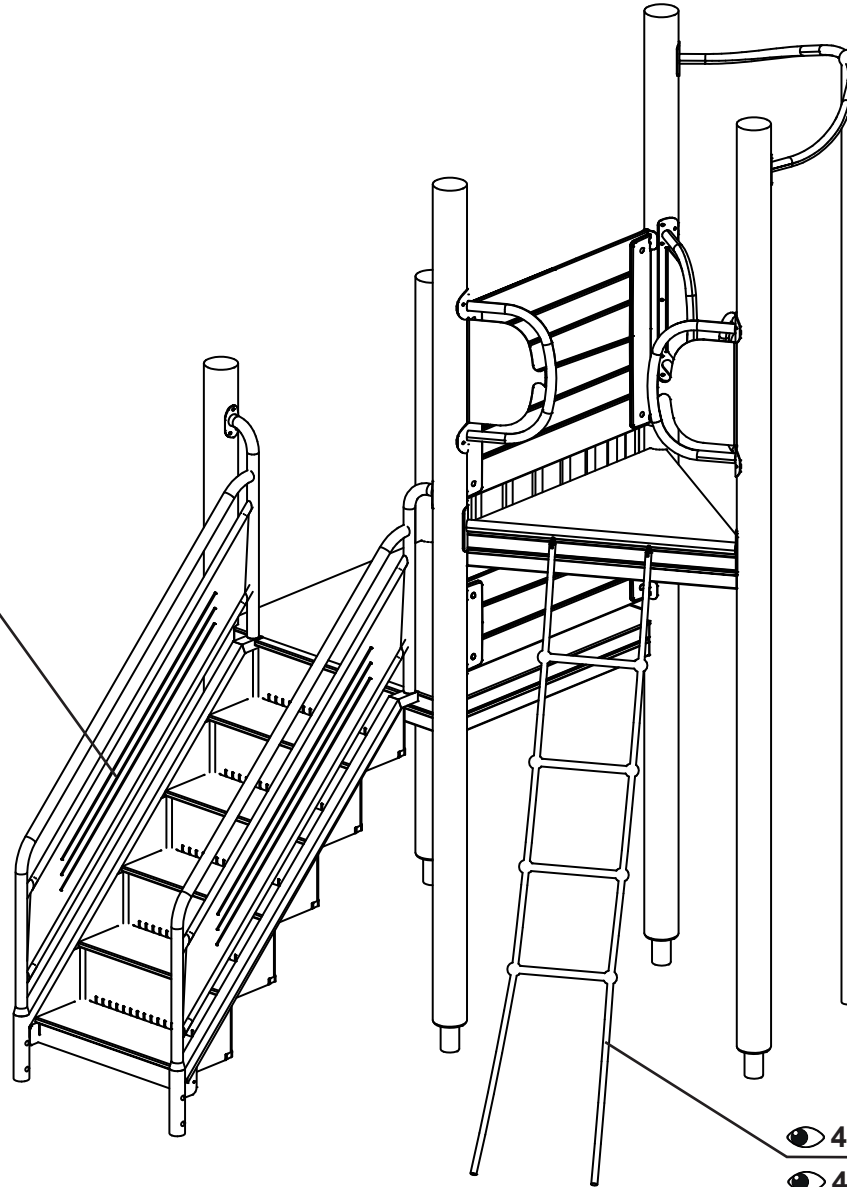

● 45077011 [SF]
● 45277011 [OM]
● 45477011 [BM]

● 45072010 [SF]
● 45272010 [OM]
● 45472010 [BM]

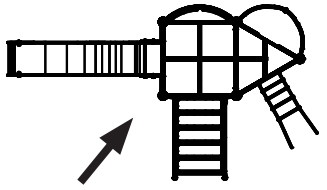

👁 MASW39775
x5

- 👁 453212 [SF]
- 👁 452212 [OM]
- 👁 454212 [BM]

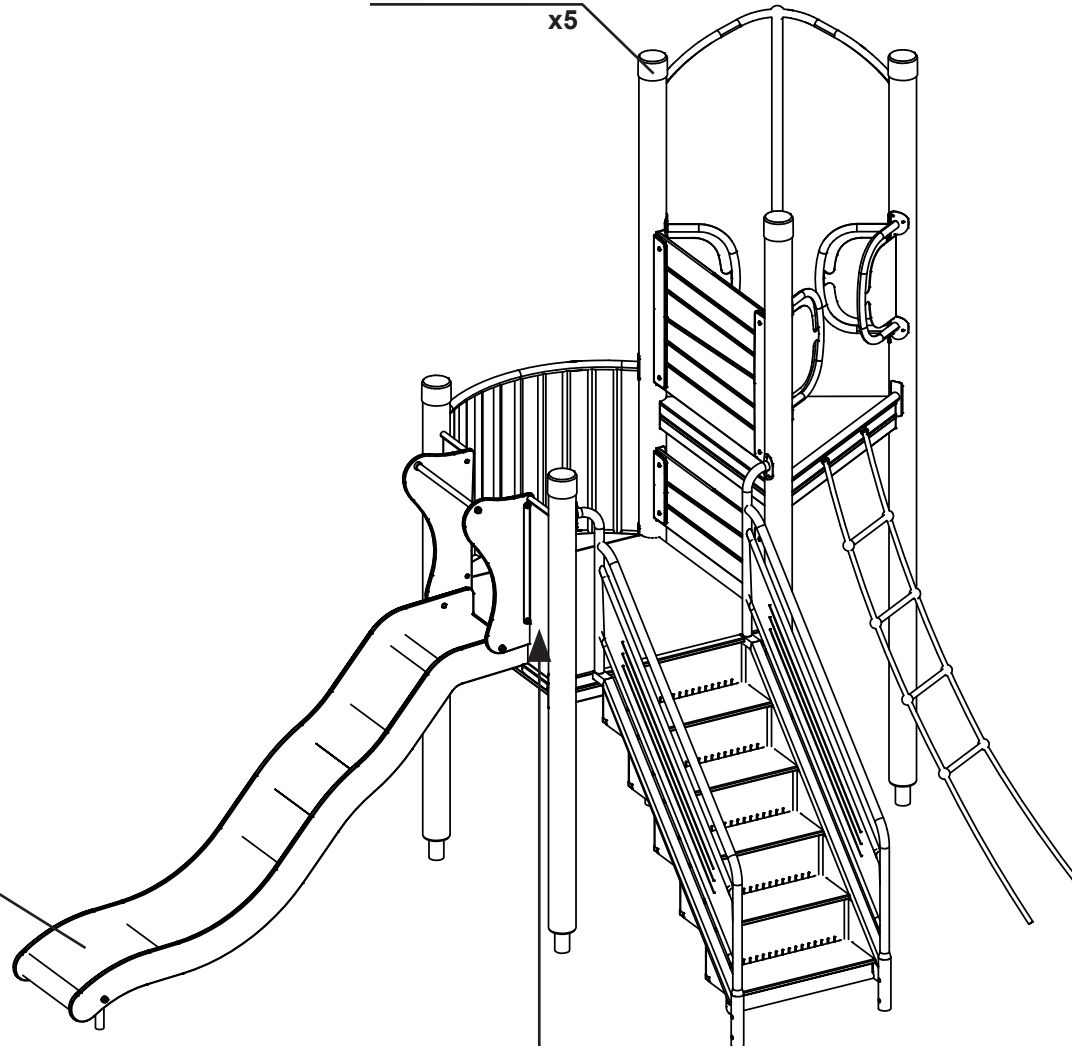

HAGS
260329